



GARDTEC

Revision	Date	Approved	Name

Part Number:

SC92-W2B

Material: C1008 Steel
Finish: Black E.D
Ring Diameter: 1.6mm
Rib Diameter: 1.8mm
General Tolerance Unless Noted: $\pm 0.5\text{mm}$
Unit: mm
RoHS Compliant

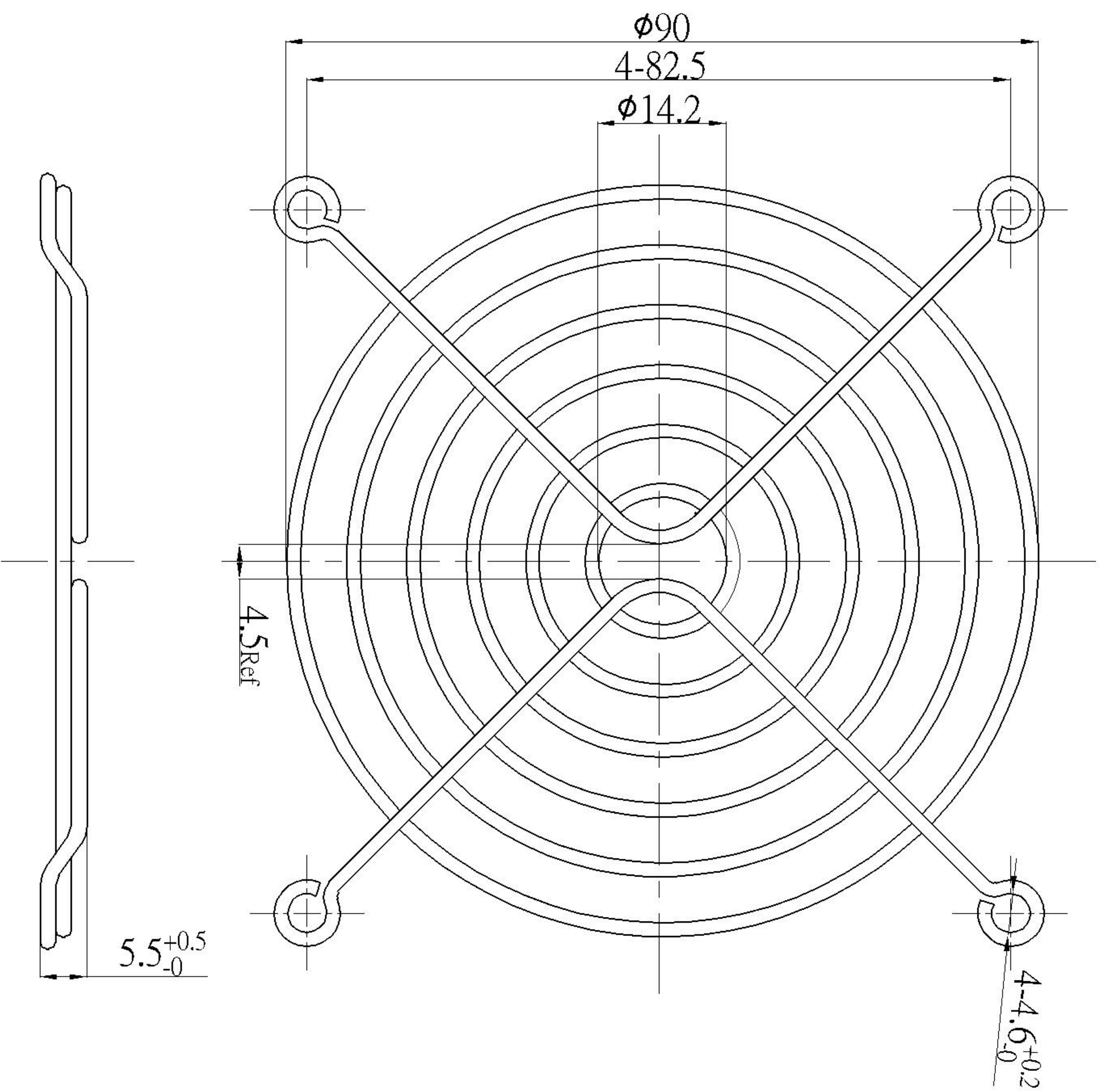

These drawings are the property of Gardtec, Inc and cannot be reproduced for or communicated to a third party without the express written permission of Gardtec, Inc.

GardTec, Inc. • 2909 Mt. Pleasant Street • Racine, WI USA

Questions or to order please call

(262) 634-5560

www.gardtecinc.com